

Tank installation for Hydrogen Peroxide

Construction, technical equipment and operation

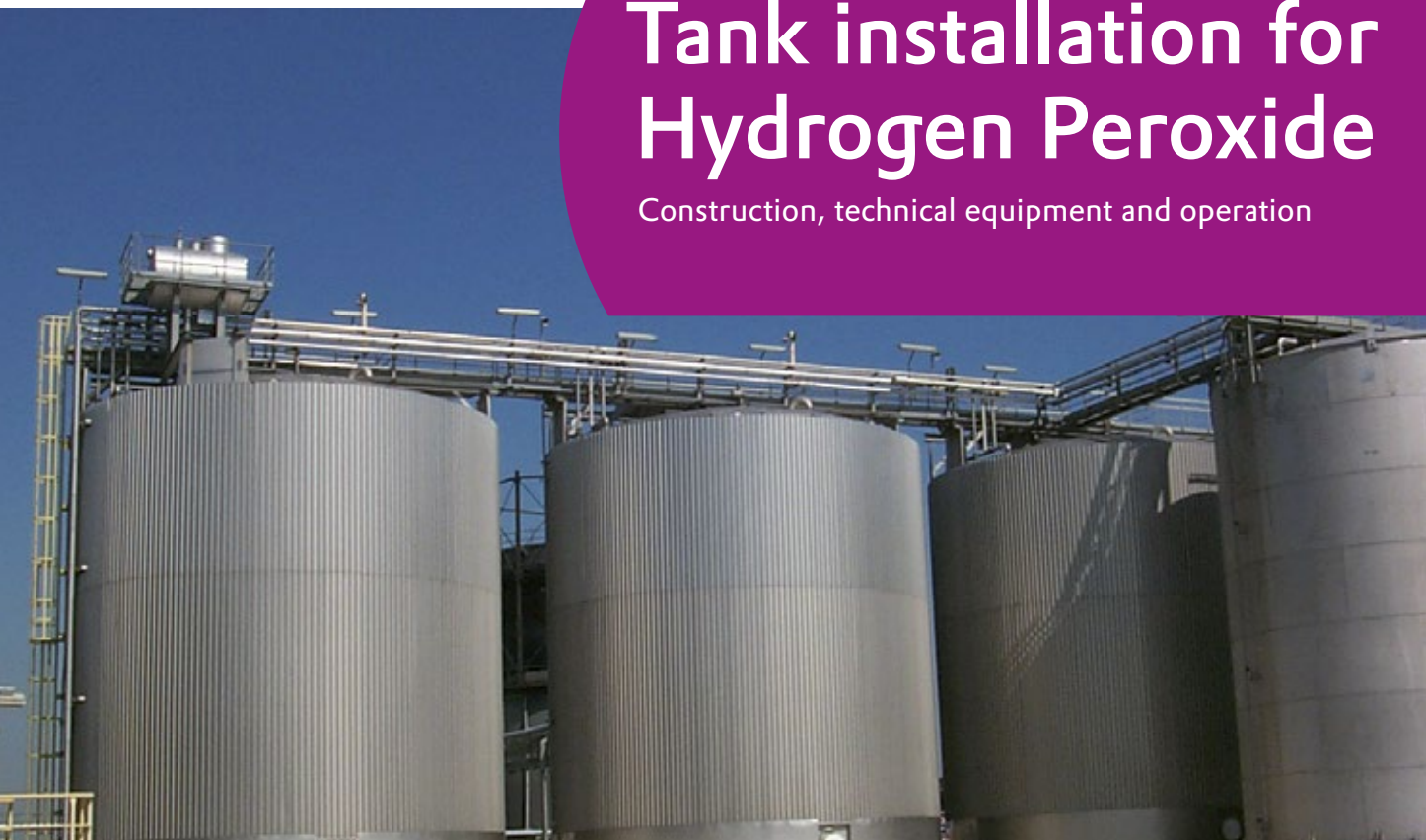

Content

1. Introduction	3
2. General principles	4-7
2.1. Decomposition	4
2.2. Choice of materials	5
2.3. Fire and explosion risk	5
2.4. Regulations and directives - Transport and safety	6
2.5. Regulations and directives – Construction and properties	7
3. Construction of H₂O₂ tank installations	8-13
3.1. Location, construction method	8
3.2. Storage tank	9
3.3. Pumping and metering equipment	10
3.4. Pipework and fittings	11
3.5. Safety devices on storage tank	12
3.6. Safety devices on pipe system	13
4. Description of operating procedure	14-15
4.1. Cleaning and pre-treatment	14
4.2. Filling the storage tank	15
4.3. Discharge from storage tank	15
4.4. Tank installation maintenances	15
5. Emergency and accident procedure	16
5.1. Decomposition of hydrogen peroxide in storage tank	16
5.2. Firefighting	16
5.3. First aid	16
6. Vendor managed inventory (VMI)	17
6.1. What does VMI mean?	17
6.2. Benefits of VMI	17
6.3. Infrastructure of VMI	17
6.3. Supply of the VMI system by Evonik	17
7. Services of Evonik	19

1. Introduction

Hydrogen peroxide (H_2O_2) is a reactive oxidation chemical and is used in many different industrial and commercial applications including pulp bleaching, chemical synthesis, semiconductor manufacture and environmental remediation. Typical industrial products are concentrations with 35%, 50%, and 70% H_2O_2 by weight aqueous solutions. If annual consumption volume reaches a level which justifies bulk deliveries by rail or road, customized H_2O_2 storage and dosing may become an option.

Industrial grades of hydrogen peroxide are strong oxidizers, corrosive and contain considerable potential energy. Millions of tons of hydrogen peroxide are however safely transported and stored each year around the globe. Safe handling begins with the construction and safe operation of hydrogen peroxide tank installations.

This brochure provides information on hydrogen peroxide bulk storage tank construction, equipment and operation, as well as safety and handling guidance.

Additional information is available at the Evonik website www.evonik.com/h2o2



2. General principles

Hydrogen peroxide continuously decomposes to water and oxygen gas through a natural process. This is acceptable for storage locations if the decomposition rate is kept low. Contamination with metals and other materials can cause a rapid and dangerous decomposition with a drastic rise in temperature and pressure. Risk can be greatly minimized through careful tank design, construction and operation.

2.1 Decomposition

The solutions of hydrogen peroxide available commercially are adequately stabilized, so that the rate of decomposition if properly handled is extremely low. Despite this, hydrogen peroxide should never be kept in a hermetically sealed container. This would otherwise result in a pressure increase due to the oxygen released during decomposition. This means in practice that tanks, pipelines, pumps, pipe fittings etc. must always be provided with the appropriate vents or pressure relief devices.

Impurities of any kind, in particular alkalis, numerous metals and their compounds, organic substances and also dirt or dust - encourage exothermic spontaneous decomposition of hydrogen peroxide. It is therefore important that hydrogen peroxide is protected against all types of contamination. Once hydrogen peroxide has been removed from a storage tank, it may never be returned to it. This reduces the risk of contamination.

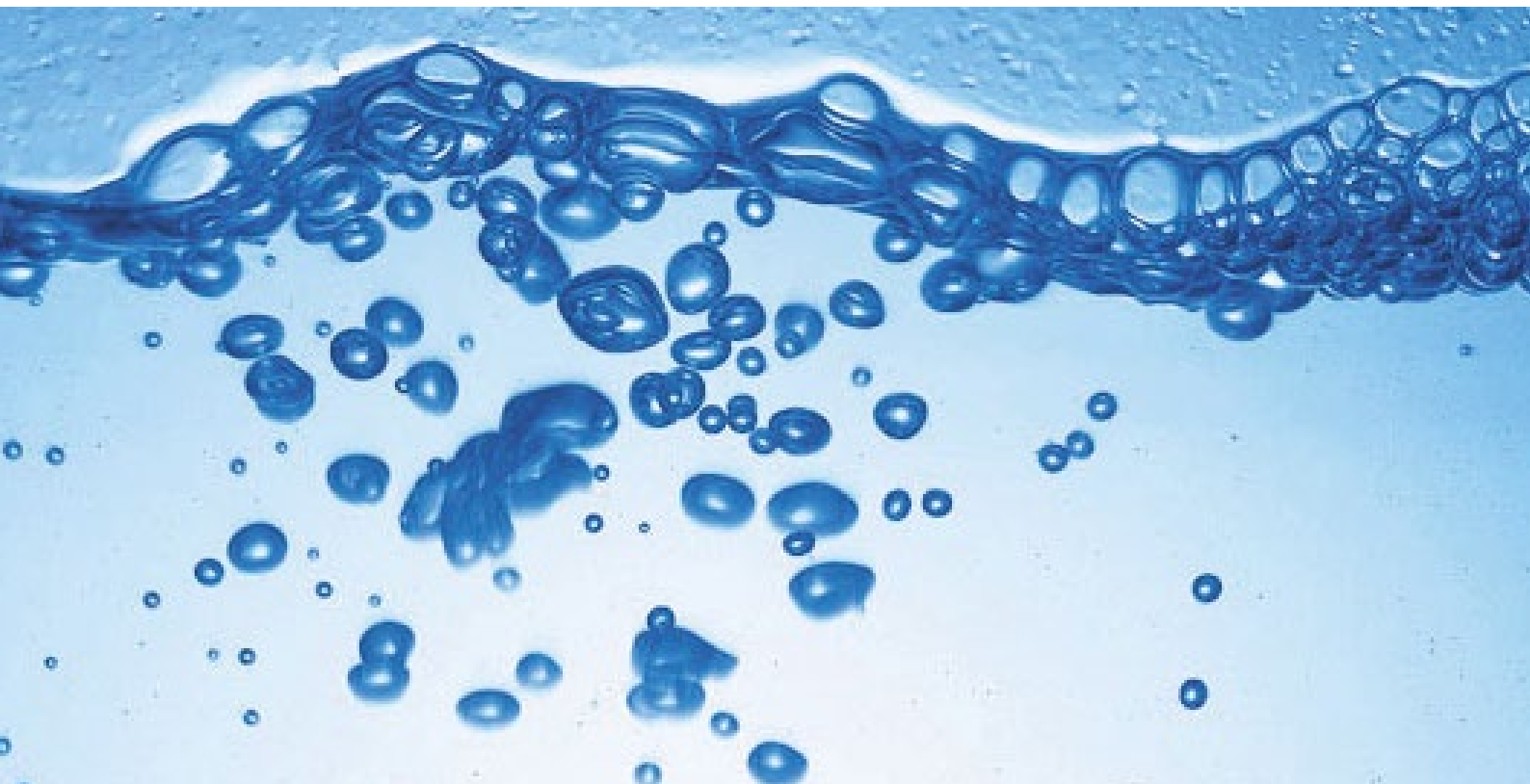

2.2 Choice of materials

For the same reason, only certain materials are suitable for the construction of hydrogen peroxide tank installations. Among these are various plastics, aluminum and stainless steel grades.

The choice of materials is also influenced by the concentration of the hydrogen peroxide solution and the length of the contact period.

2.3 Fire and explosion risk

Hydrogen peroxide solutions themselves are non-flammable, but as their concentration increases, they have the effect of encouraging combustion. Organic substances which can be oxidized may catch fire when in contact with hydrogen peroxide. Mixtures of hydrogen peroxide and flammable liquids (solvents) at various concentrations may become explosive and sensitive to impact. For these reasons, hydrogen peroxide must be kept away from flammable substances.

Note additionally that oxygen is formed as hydrogen peroxide solutions decompose, and can form combustible mixtures with solvent vapors.

If decomposition is severe (contact with impurities), the resulting gas pressure (oxygen, water vapor) may even rupture correctly vented containers.

2.4 Regulations and directives – Transport and safety

For conveyance by road, rail or ship, the various concentrations of hydrogen peroxide have been allocated to the following risk categories:

Concentration of H ₂ O ₂	8% < H ₂ O ₂ < 20%	20% ≤ H ₂ O ₂ ≤ 60%	H ₂ O ₂ > 60%
Orange Panel	50	58	559
UN-No.	2984	2014	2015
IMDG-Code, RID/ADR	5.1; 2984; PG.III	5.1; 2014; PG.II	5.1; 2015; PG I
Labels	5.1	5.1+8	5.1+8

Classification of aqueous H₂O₂ solutions according to the European Regulation No. 1272/2008

8% ≤ H ₂ O ₂ < 35%		
Hazard statements	H302 H318	Harmful if swallowed Causes serious eye damage
Prevention statements	P261 P280	Avoid breathing dust, fume, gas, mist, vapors, spray Wear protective gloves, and clothing; eye and face protection
35% ≤ H ₂ O ₂ < 50%		
Hazard statements	H302 H315 H318 H335	Harmful if swallowed Causes skin irritation Causes serious eye damage May cause respiratory irritation
Prevention statements	P261 P280	Avoid breathing dust, fume, gas, mist, vapors, spray Wear protective gloves, and clothing; eye and face protection
50% ≤ H ₂ O ₂ < 70%		
Hazard statements	H272 H314 H302 H332 H335	May intensify fire; oxidizer Causes severe skin burns and eye damage Harmful if swallowed Harmful if inhaled May cause respiratory irritation
Prevention statements	P210 P261	Keep away from heat, sparks, open flames, hot surfaces No smoking Avoid breathing dust, fume, gas, mist, vapors, spray
70% ≤ H ₂ O ₂		
Hazard statements	H271 H314 H302 H332 H335	May cause fire or explosion; strong oxidizer Causes severe skin burns and eye damage Harmful if swallowed Harmful if inhaled May cause respiratory irritation
Prevention statements	P210 P261	Keep away from heat, sparks, open flames, hot surfaces No smoking Avoid breathing dust, fume, gas, mist, vapors, spray





2.5 Regulations and directives – Construction and properties

Hydrogen peroxide solutions with a content of >8 % by weight are dangerous substances, e.g. according to the European directive 67/548/EEC. They must be labeled and handled correspondingly. Please refer to our material safety data sheet for details.

Operators of hydrogen peroxide tank installations are required to issue the appropriate operating instructions to ensure reliable working procedure.

Items needed for protective purposes (goggles/face masks, gloves, protective clothing) must be made available. A safety poster is available upon request and illustrates the basic safety rules to follow when handling hydrogen peroxide.

As with other tank installations, those for hydrogen peroxide are subject to local construction and trade regulations and directives. The operator is responsible for obtaining all the necessary permits or planning authorization.

Hydrogen peroxide is a chemical, which can be used without unfavorable environmental effects, since its products of reaction and decomposition are only water and oxygen. In the soil, in the drainage system or in water, hydrogen peroxide is rapidly reduced or decomposed to water and oxygen, so that no permanent adverse effects on water quality result.

Note: For further details of product characteristics and handling methods, please refer to our product brochure "Hydrogen Peroxide - Leadership through innovation".

3. Construction of hydrogen peroxide tank installations

3.1 Location, construction method

Tank installations can be set up in the open air but should be protected from extremes of temperature. To increase operational security (i.e. prevent tank damage, reduce fire risk, general personnel protection) the tank must be erected in a dedicated containment area. Running water must be provided in the immediate area so that spills can be diluted. Because hydrogen peroxide is an oxidizer the storage area should be located away from flammable or combustible material such as paper, wood or any other organic materials.

If the tank is made of metal, an earth (ground) strap must be led down through the foundation slab.

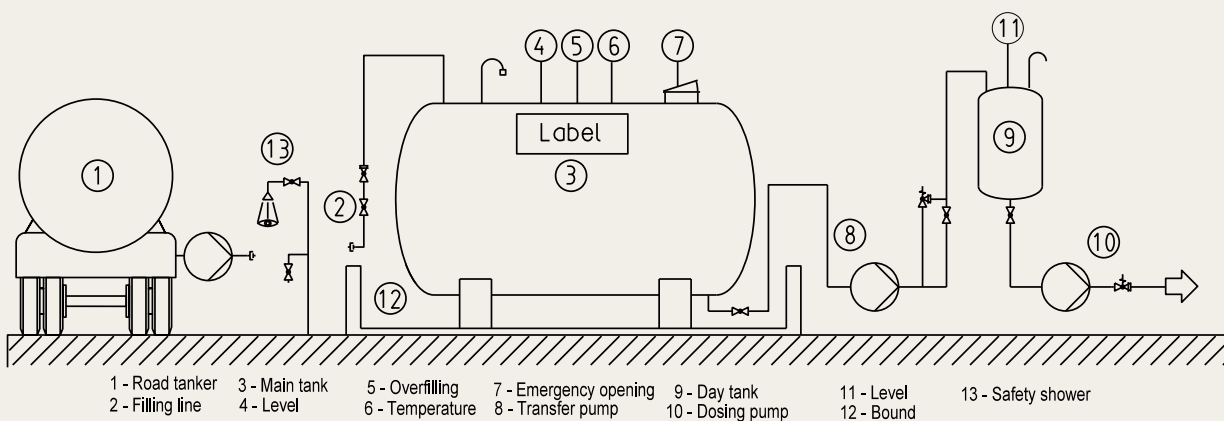

3.2 Storage tank

For safety reasons, hydrogen peroxide tanks may not have any openings such as fillings or drainage unions, manholes, sight glasses or level indicators below the liquid level.

Discharge takes place through a suction riser pipe terminating in a suction cup, and arranged to allow the tank to be discharged completely.

Suitable materials for the storage of hydrogen peroxide at all concentrations are a set of stainless steels (e.g. (316Ti) 1.4571, (316L), 1.4404), pure aluminum (at least 99.5% quality) and certain aluminum magnesium alloys (Al-Mg). Tanks of this kind can be of several hundred cubic meters capacity.

For hydrogen peroxide concentrations up to 60% by weight, storage tanks made from various plastics are also suitable.

The best results have been obtained with seamless wrapped low-pressure polyethylene (PE-HD) tanks. For stress-analysis reasons, these tanks can only be set up vertically. Their maximum capacity is in the range of 50 cubic meters.

Storage tanks must be thoroughly cleaned before initial filling; metal tanks must be pickled and passivated (see also 4.1).

For necessary safety devices, see 3.5.



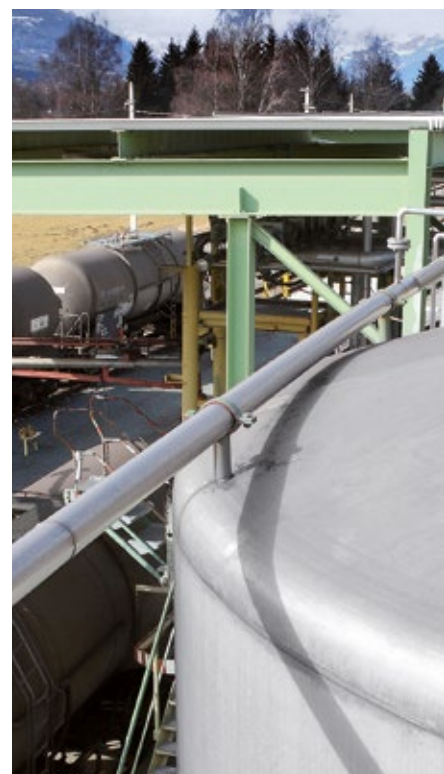

3.3 Pumping and metering equipment

To draw hydrogen peroxide out of mobile vessels (rail or road tankers or container-type tanks), a self-priming pump is needed. It must discharge into the storage tank from the top.

The best results have been obtained with single-stage pumps made from stainless steel (e.g. 1.4581 and 1.4571), with external anti-friction bearings and mechanical seals or hermetically sealed pumps with permanent magnetic coupling. A similar pattern of pumps is used to discharge the storage tank.

On smaller installations, with a capacity of up to approximately 10 cubic meters, the storage tank can be filled and discharged by the same pump if provision is made for this during construction (the desired flow rate is approximately 5 cubic meters/hour).

This is shown in diagram 3.1. On larger installations, two pumps of differing ratings will be needed (filling rate approximately 20 cubic meters/hour, discharge rate approximately 2 cubic meters/hour). The discharge pump delivers the hydrogen peroxide to a dosing tank (with level control). The dosing tank has two functions: first of all to prevent liquid running back from the process point to the storage tank (with the associated risk of contamination), and secondly to build up pressure for the downstream dosing pump.

Dosing pumps are normally employed for subsequent distribution of the product (e.g. plunger or membrane type, stainless steel 1.4571/PTFE). Since slight gasification is typical of hydrogen peroxide, these dosing pumps cannot operate with any great degree of accuracy unless the product reaches them by free fall (gravity feed) or at a suitable initial pressure.

The dosing tank can also function as a measuring tank, in which case the dosing pump will not be needed.

Pressure discharge of hydrogen peroxide storage tanks is not normally recommended because of the associated risk of contamination (rust, oil, etc.). Furthermore, it is not permitted on plastic tanks since these are unable to withstand the resulting higher internal pressures.



3.4 Pipework and fittings

For hydrogen peroxide concentrations up to 50% by weight, pipework of rigid PVC 100 (chemical construction series 5) has proved successful; it is extremely simple to install, with adhesive joints between the sections. Shutoff valves or ball cocks of the same material can be obtained.

Up to a concentration of 60% by weight, PE or PVDF plastics can also be used, but are not so simple to install since heat-bonding is necessary in both cases.

For higher hydrogen peroxide concentrations, it is advisable to use stainless steel (e.g. material no. 316 Ti/1.4571) or aluminum (Al 99.5).

These materials must be manufactured by inert or nitrogen-hydrogen gas welding, and pickled and passivated before initial use (see 4.1).

In view of the corrosion risk, no electrically conductive joints between different metals may be permitted at any pipe connections or unions. The most suitable seal material is soft PVC, FPM, "PTFE" or PTFE based material for concentrations above 60% by weight. Please refer to 3.5. for details of safety devices.



3.5 Safety devices on storage tank

The following safety devices are normally installed on hydrogen peroxide storage tanks:

- connecting piece for aeration and venting, equipped with vent fittings as protection against dust and splash water
- a flexible manhole cover fastened so as to act as an additional pressure relieving device
- a level indicator with maximum and minimum level contacts
- an overfilling protection device in the form of a level indicator with a limit switch for an alarm device and to halt the filling pump
- a leak warning device in form of a level indicator with a switch for alarm in the tank containment area
- temperature monitoring by resistance thermometer (Pt. 100) or thermocouple; alarm device to indicate when the present maximum temperature has been exceeded
- sun protection (in tropical and desert regions necessary)
- provision for tank flooding in the event of severe decomposition, by way of the filling, flooding or discharge line
- label (general handling description, personal safety equipment, product name)
- earthing (electrical grounding) of metal storage tanks

3.6 Safety devices in the pipe system

Although spontaneous decomposition is only slight, hydrogen peroxide must never be trapped between valves etc. at any point in the pipe system. If possible, lines to the consumer side of the plant should be arranged to discharge freely (downward inclination). It is essential to prevent hydrogen peroxide from flowing back to the tank (risk of contamination).

If valves have to be installed in such a way that there is a risk of hydrogen peroxide being trapped, a means of pressure equalization must be provided in the form of flow-relief safety valves.

The same safety precautions apply to all other elements of the installation (pumps, pipe fittings, volumetric flow meters, "Rota meters", etc.), in which hydrogen peroxide could be trapped. For example, if ball valves are provided for shutoff purposes, a compensating hole must be drilled in the ball.

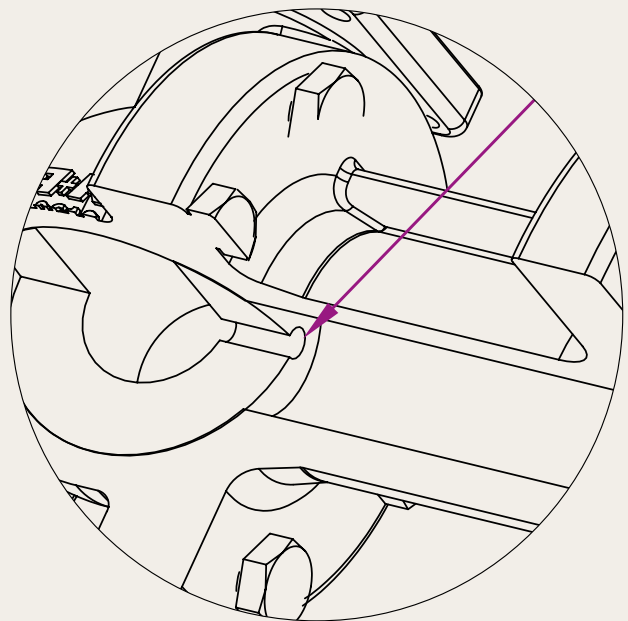
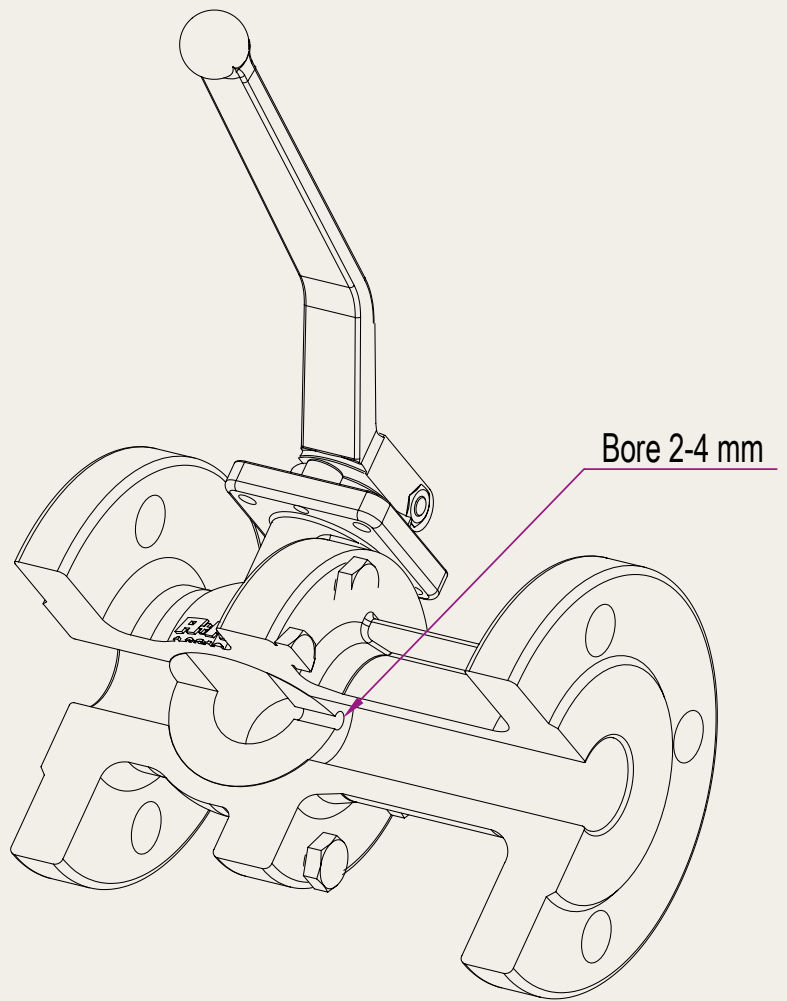

4. Description of operating procedure



4.1 Cleaning and pre-treatment

Before the tank installation is filled for the first time, all parts must be thoroughly cleaned and flushed. Metal elements of the installation must first be pickled and passivated. We can supply the relevant instructions upon request (see 7).

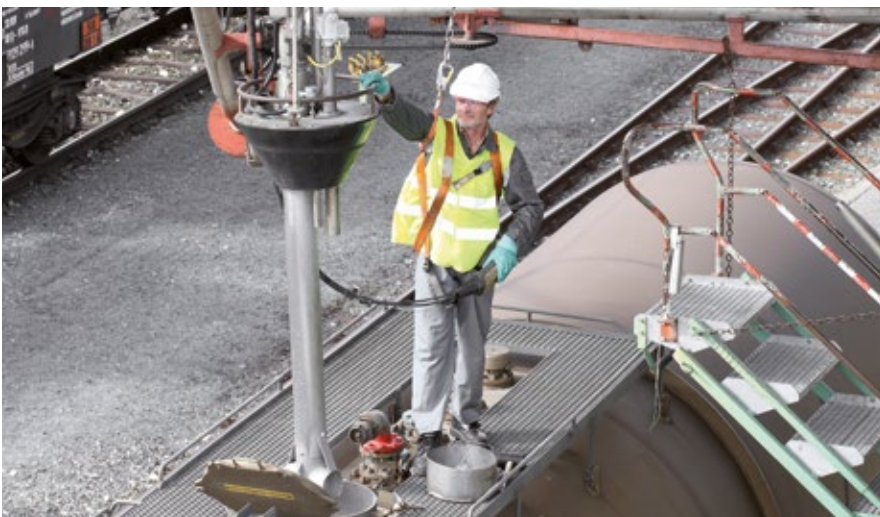

4.2 Filling the storage tank

Storage tank and handling equipment have to be designed according to the local Health & Safety regulations. To ensure that the safety facilities function correctly, the personnel have to wear safety equipment and the operation must be carried out according to the work instructions. A responsible member of the customer's staff must supervise the filling procedure. The tanker discharge hose is connected to the unloading pump's suction pipe coupling.

All hydrogen peroxide equipment must be dedicated. Use different couplings to those used for other chemicals to avoid mix-ups. The filling procedure can be done by the filling pump of the storage plant or by the electrically driven transfer pump of the road tanker. In this case, the power supply for the pump is controlled by the level- and overfilling indicator of the tank, which shuts down the pump to avoid overfilling. After ending the transfer procedure, the dust cap on the coupling has to be replaced.

4.3 Discharge from storage tank

After operating the valves, the pump can be run to fill the intermediate tank. During plant operation, valves can remain open if the intermediate tank is placed at a higher level, since dosing tank filling is controlled by an automatic level probe circuit. The pressure-loaded relief valve prevents damage to the pipework should the pump be accidentally run with the valves closed or hydrogen peroxide has generated gas as a result of normal decomposition in the pump or pipework.

The hydrogen peroxide is distributed to the consumer points by the dosing pump, which draws the product from the dosing tank. A back flow from the intermediate tank to the storage tank must be prevented.

On larger tank installations, two pumps of different dimensions and flow rates are used to fill and discharge the storage tank, but are operated in a manner similar to that just described.

4.4 Tank installation maintenance

Hydrogen peroxide handling systems require special engineering knowledge of for example materials of construction & fabrication techniques. Only qualified companies with the necessary ability and knowledge of the special constructions and suitable materials for hydrogen peroxide may carry out the repair, modification and cleaning of storage tanks.

Storage tanks and pipe systems must be regularly inspected for signs of leakage. The correct operation of the various mechanical assemblies and safety devices must also be checked at frequent intervals.

For all repair work, make quite sure that suitable materials are used and the correct pre-treatment is applied during cleaning, with pickling and passivation of metals (see 7).

5. Emergency and accident procedure

5.1 Decomposition of hydrogen peroxide in storage tank

In case of decomposition, it is essential to have a pre-planned emergency response plan. All personnel directly or indirectly involved in the storage and use of hydrogen peroxide shall be familiar with this emergency response plan.

The start of hydrogen peroxide decomposition, caused by impurities, is indicated by a build-up of heat inside the tank compared with the surrounding temperature. The speed of the decomposition reaction and the increasing temperature depends upon the degree of contamination. In many cases, the initial temperature increase may be slow, so that after reaching the temperature alarm point of approximately 30-35° Celsius, there is enough time to initiate the following emergency procedures:

- Immediately clear the surrounding area
- Prepare to flood the tank with a suitable water quality when the temperature reaches 35° Celsius (connect a fire hose to the fill-line)
- Flood the tank from within a safe distance when the temperature reaches 45° Celsius.

Due to the flooding, the somewhat diluted contents will be forced out of the manway. The overflow of the tank should either be collected & diluted, or immediately diluted in situ with enough water to meet the requirements of the local wastewater authorities.

If the emergency procedures are not started quickly, and the temperature has already reached 50° Celsius, the speed of reaction, combined with the temperature increase, will be rapid and a rupture of the tank could follow in quick succession.

5.2 Firefighting

Fires which occur in the presence of hydrogen peroxide must be extinguished with plenty of water. This ensures adequate dilution and also reduces the product's ability to encourage combustion.

5.3 First Aid

Hydrogen peroxide is corrosive to the skin and eyes. Eye wash & safety shower units must be readily accessible. Further details of first aid procedures are given in our safety data sheet (SDS).



6. Vendor managed inventory (VMI)

6.1 What does VMI mean?

A vendor managed inventory system is a combination of tank level monitoring, evaluation and automated hydrogen peroxide supply. Evonik offers, in conjunction with a hydrogen peroxide supply, a web-based system – that is linked by telephone line, (for example, analog/DSL/mobile phone) to the customer's tank.

6.2 Benefits of VMI

This system collects a wide range of data needed to fulfill our requirements for the most reliable, cost-efficient use of bulk hydrogen peroxide. The tank level monitoring system can easily be configured to provide both you and Evonik with an array of information, such as hourly inventory levels, consumption trend data and models of future demand. All data are available for the customer over a password-protected website.

6.3 Infrastructure of VMI

Evonik will provide a modern panel for transmission of the data. It must be situated in the vicinity of the storage tank and will require a suitable power supply, e.g. 230 VAC/110 VAC/24 VDC and a continuous analog signal 4-20mA from the tank level indicator.

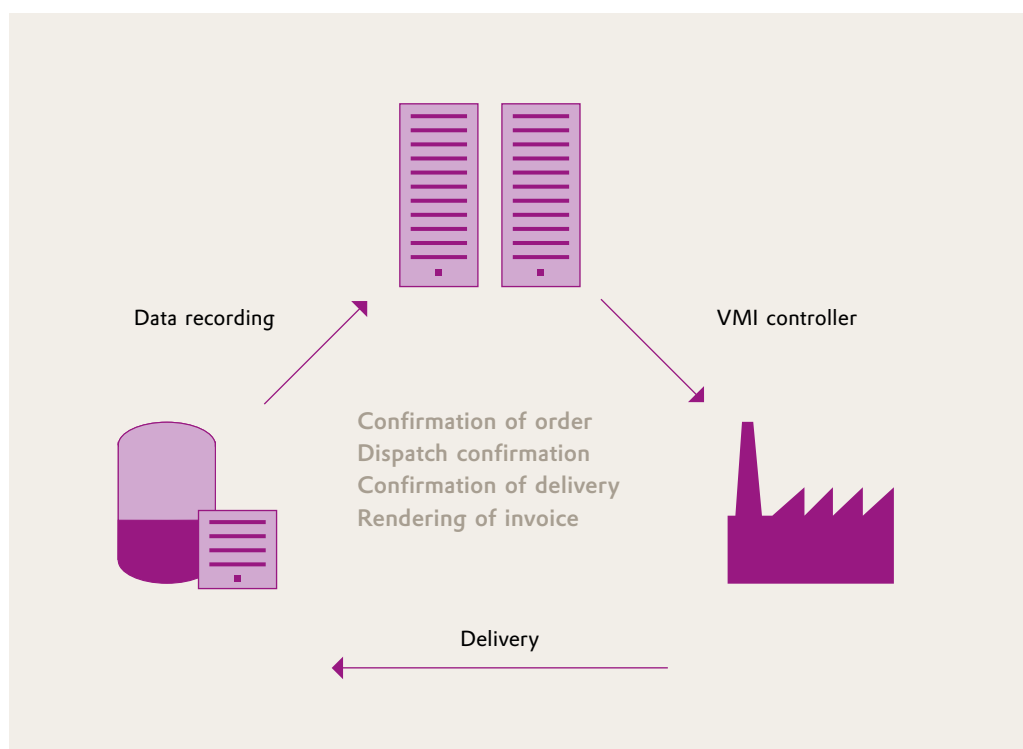

6.4 Supply of the VMI system by Evonik

Before supplying the tank level monitoring system package, the following will be required:

1. Conclusion of basic agreement
2. Check of available technology and networking options
3. Installation and calibration of the measuring and transmitting devices
4. Fixing use and data transfer requirements:
 - Confirmation of order
 - Dispatch confirmation
 - Confirmation of delivery
 - Rendering of invoice



7. Services of Evonik

It is our declared policy to pass on our many years of experience with hydrogen peroxide to our customers. This includes the planning and construction of tank installations.

Our service can cover:

- Initial consultation
- Project planning and construction work
- Start-up
- Repair and modification work on hydrogen peroxide installations
- Pre-delivery inspection

Our technology team of highly qualified and experienced specialists can assist you in any aspect regarding the storage and handling of hydrogen peroxide.

Our statements concerning our products and applications, plant and processes are based on comprehensive research and technical application experience. We communicate these results, with which we do not assume any liability over and beyond the individual agreement, orally and in writing, to the best of our knowledge, but reserve the right to technical alterations in the course of product development. Our technical applications service is moreover available on request for further consultation or cooperation to solve technical manufacturing and application problems.

This does not, however, release the user from himself examining on his own responsibility our statements and recommendations prior to applying them for his own use. This applies – particularly for deliveries abroad – also with regard to the observance of industrial property rights of others, as well as to application and process methods that we do not explicitly state in writing. Our liability in case of damage is limited to our obligation to replacement delivery in the same scope as our general conditions and terms of sale and delivery provide in the case of quality deficiencies.

Disclaimer

This information and all further technical advice is based on our present knowledge and experience. However, it implies no liability or other legal responsibility on our part, including with regard to existing third party intellectual property rights, especially patent rights. In particular, no warranty, whether expressed or implied, or guarantee of product properties in the legal sense is intended or implied. We reserve the right to make any changes according to technological progress or further developments. The customer is not released from the obligation to conduct careful inspection and testing of incoming goods. Performance of the product described herein should be verified by testing, which should be carried out only by qualified experts in the sole responsibility of a customer.

Reference to trade names used by other companies is neither a recommendation, nor does it imply that similar products could not be used.

(April 2008)



Evonik Industries AG

Active Oxygens
Rodenbacher Chaussee 4
63457 Hanau
Germany

PHONE +49 6181 59-4122
FAX +49 6181 59-4422
www.evonik.com

Technical Service

PHONE +49 6181 59-2422
FAX +49 6181 59-3311
www.evonik.com/h2o2

Evonik. Power to create.